



**ADVENTURE  
MODE IS**



**TECHNICAL FEATURES**



**X.D1**  
dual sport

## User Options

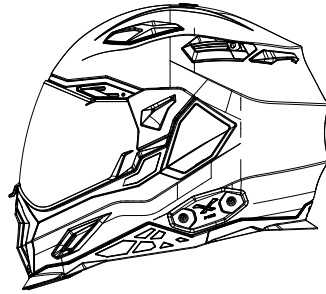

**STREET**

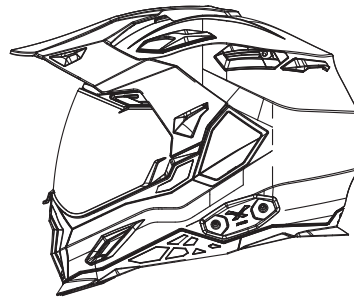

**ENDURO**

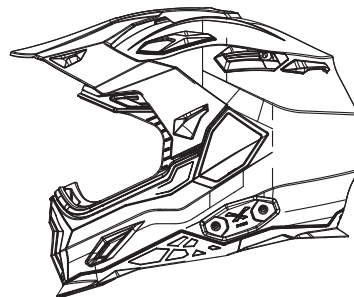

**OFF-ROAD**



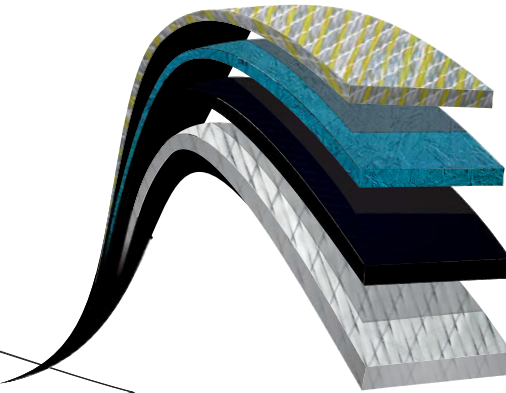

SPECIAL ARAMID  
MULTIAXIALS FIBER

3D ORGANIC FIBER

CARBON  
REINFORCEMENT

MULTIAXIAL  
FIBERGLASS

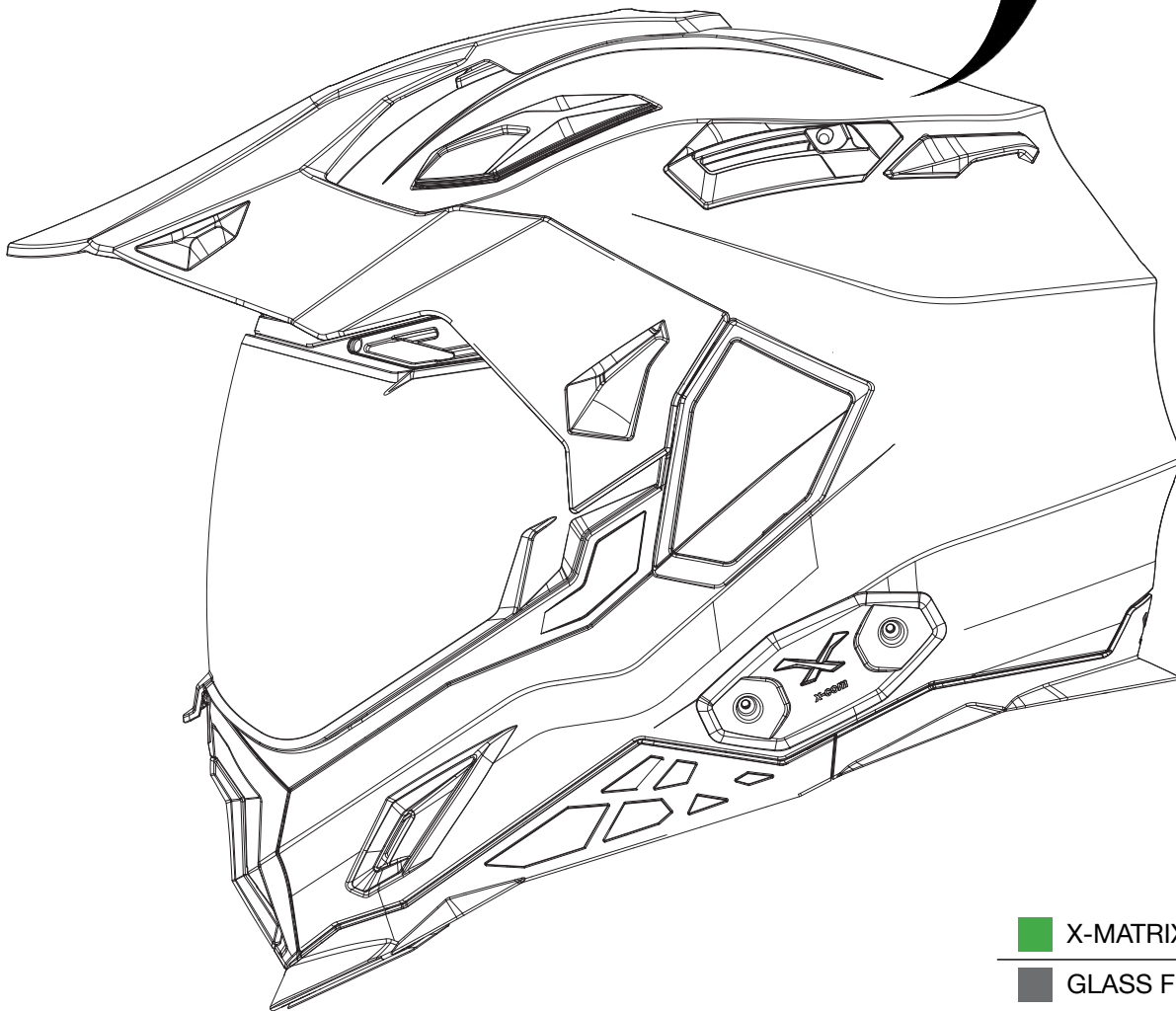

RESISTANCE AGAINST  
ENVIRONMENTAL  
INFLUENCES

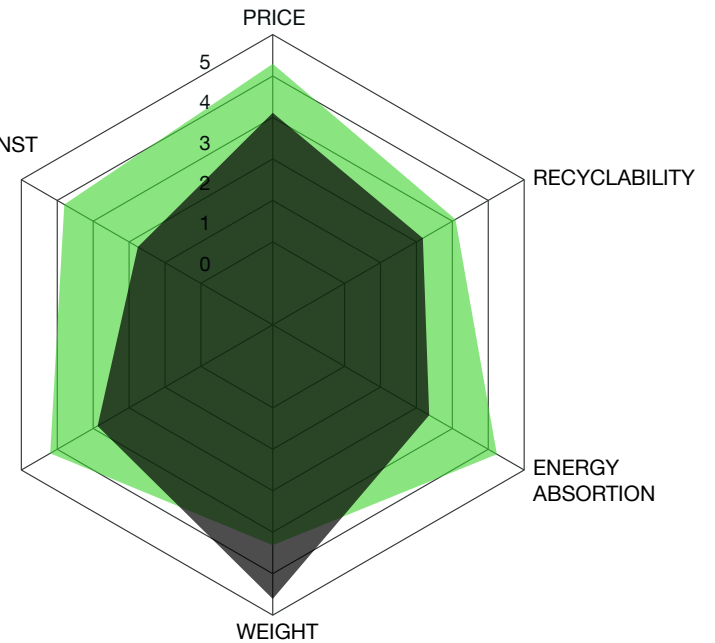

 X-MATRIX FIBER

 GLASS FIBER

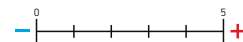

Peak Screw, No Tools  
Required

Peak Extensor

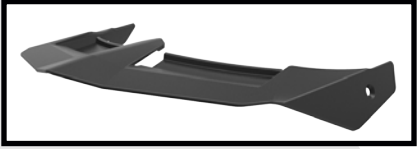

Sunvisor with  
Ergonomic Button  
Mechanism

Aerodynamic Rim  
Designed to Control Air  
Stream, Reducing Lift  
and Turbulence at High  
Speeds



NORMAL



X.D1

Special Chin Shape  
to reduce breast injury risk from  
frontal impacts

Textured Rubber Grip  
"Anti-Slip"

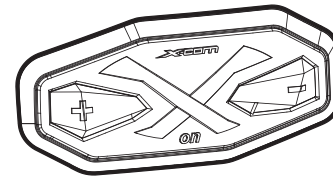

X-COM

X.D1 is by Default Equipped to Accomodate  
the NEXX Helmets X-COM Communication  
System



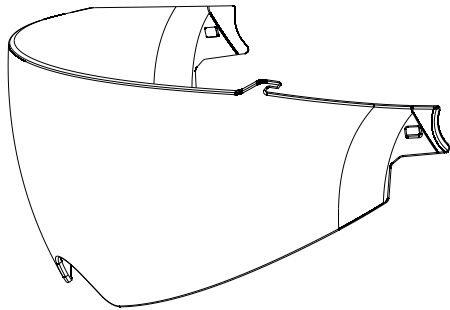

**Big Inner Sunvisor**



**FASTSHOT**  
quick release system



**FastShot with Safety Lock**

**Visor With  
Super Lock and  
Anti-Fog Position**

**Huge Eye Port**

**Visor with Recessed  
Cavity for Pinlock**



**PINLOCK**  
ORIGINAL



**Emergency Strap**

Cheek Pads With Easy Release System in Case of Crash

**Double D-Ring**

**Reflectors**

**Removable Breath Guard**

**Interior Lining Removable and Washable**



**CoolMax Fabrics**

The new 3D formed pad and Anti-noise cheek pads offer a snug fit and more effective ventilation around the entire head contour for maximum comfort and distraction-free in high speed riding.



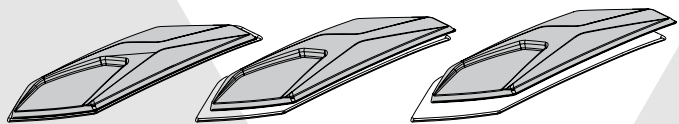

Close

Half Open

Full Open

Top Ventilation

Exhaust Vents

Standard

Off Road

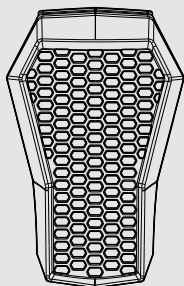
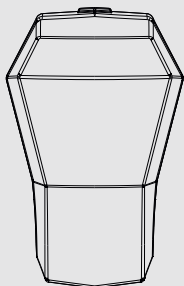

Optional Ventilation for "Off Road"

Exhaust Vents

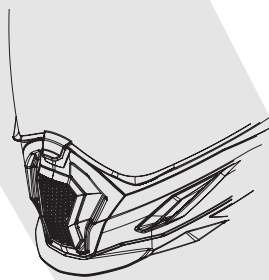
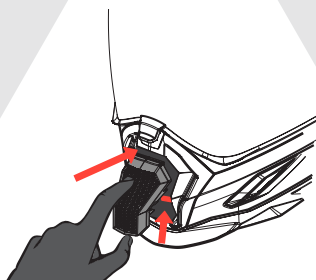
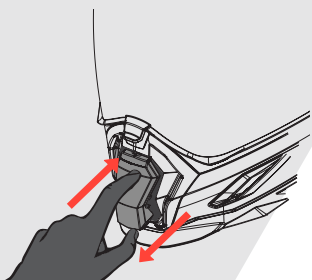



**Removable Action  
Camera Supports (Top and Sides)**

Top

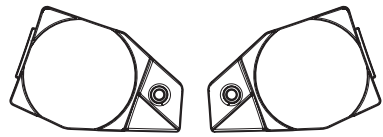
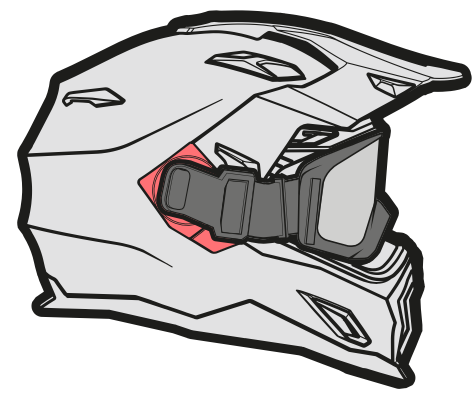
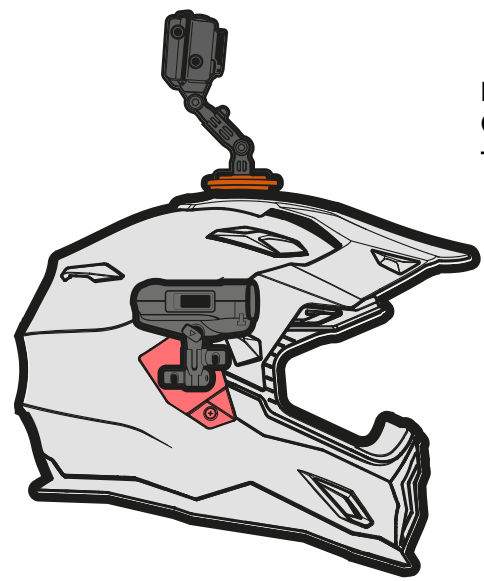
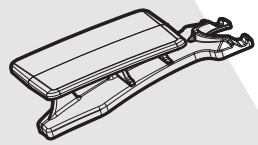

**Optional Support  
for Quick Strap**



Sides

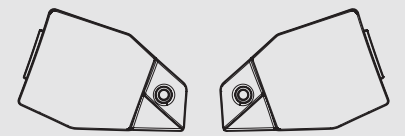



## Technical Features

- X-MATRIX Shell (multiaxial fiberglass, 3D organic fibers, special aramid fibers and carbon reinforcement)
- ECE/22-05, DOT and NBR-7471:2001
- Pinlock ready
- CoolMax Fabrics
- Double D-Ring buckle
- Panoramic Eye Port
- 3D Lining and Cheek pads
- Cheek Pads with Emergency Strap System
- Prepared for X-COM – NEXX Intercom system
- Removable Breath Guard
- 80% Tint Inner Sun visor
- PC Lexan Shield Clear with Anti-Fog position and Super Lock
- FastShot Quick Release System
- Visor with recessed cavity for pinlock
- Chin Wind stopper
- Night vision - reflectors
- Chin Ventilation
- Air Dynamic System - 2 inlets and 4 outlets air-vents
- Aerodynamic Shell & Rim
- Shell available in 2 different sizes - XS to M / L a XXL
- Ergo Padding System
- Peak Extensor
- Action Camera Support top and sides
- Optional Support for Quick Strap
- Special Chin Shape to reduce breast injury risk from frontal impacts
- Weight: 1400gr Street Version and 1500gr Dual Version

